

Measured data, $T_{amb} = 77\text{ K}$

Insertion Loss of 3 Units at 77 K

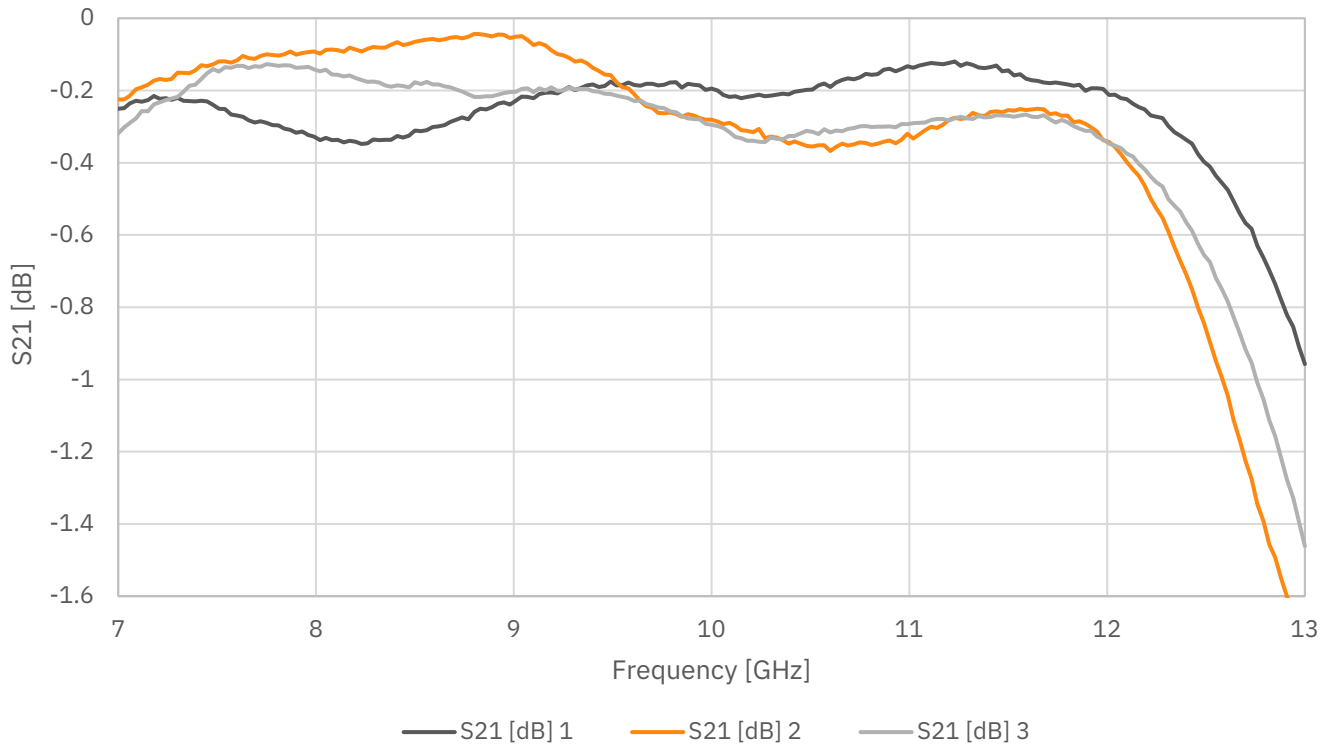

Isolation of 3 Units at 77 K

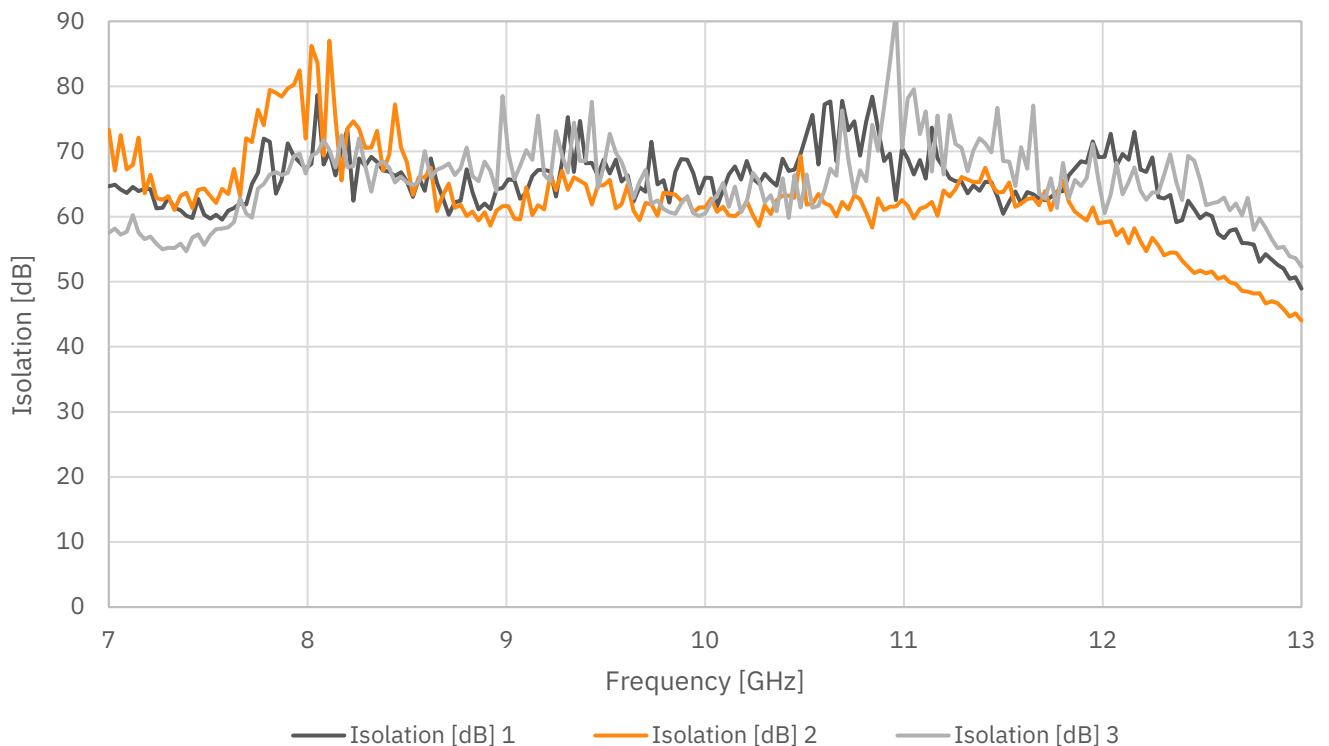

Port Match of 3 Units at 77 K

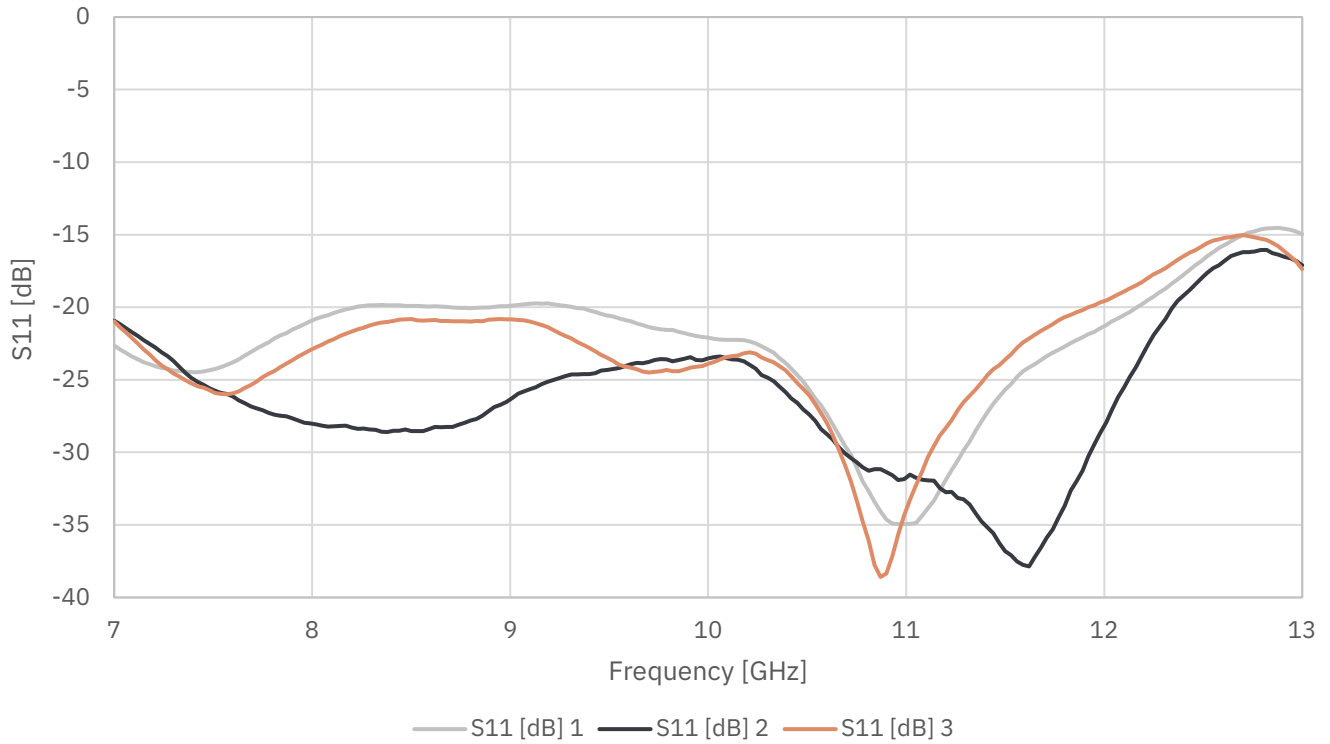

Measured data, $T_{amb} = 5\text{ K}$

Insertion Loss of 5 Units at 5 K

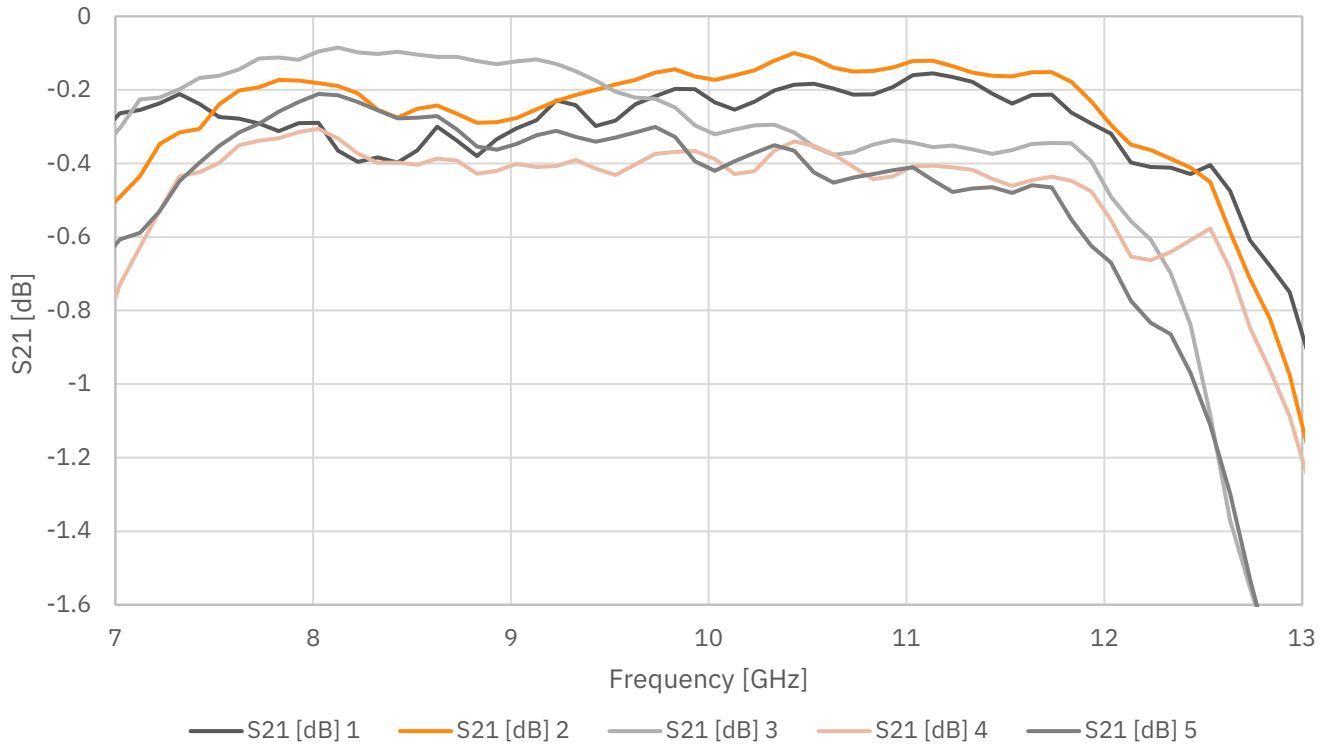

Isolation of 5 Units at 5 K

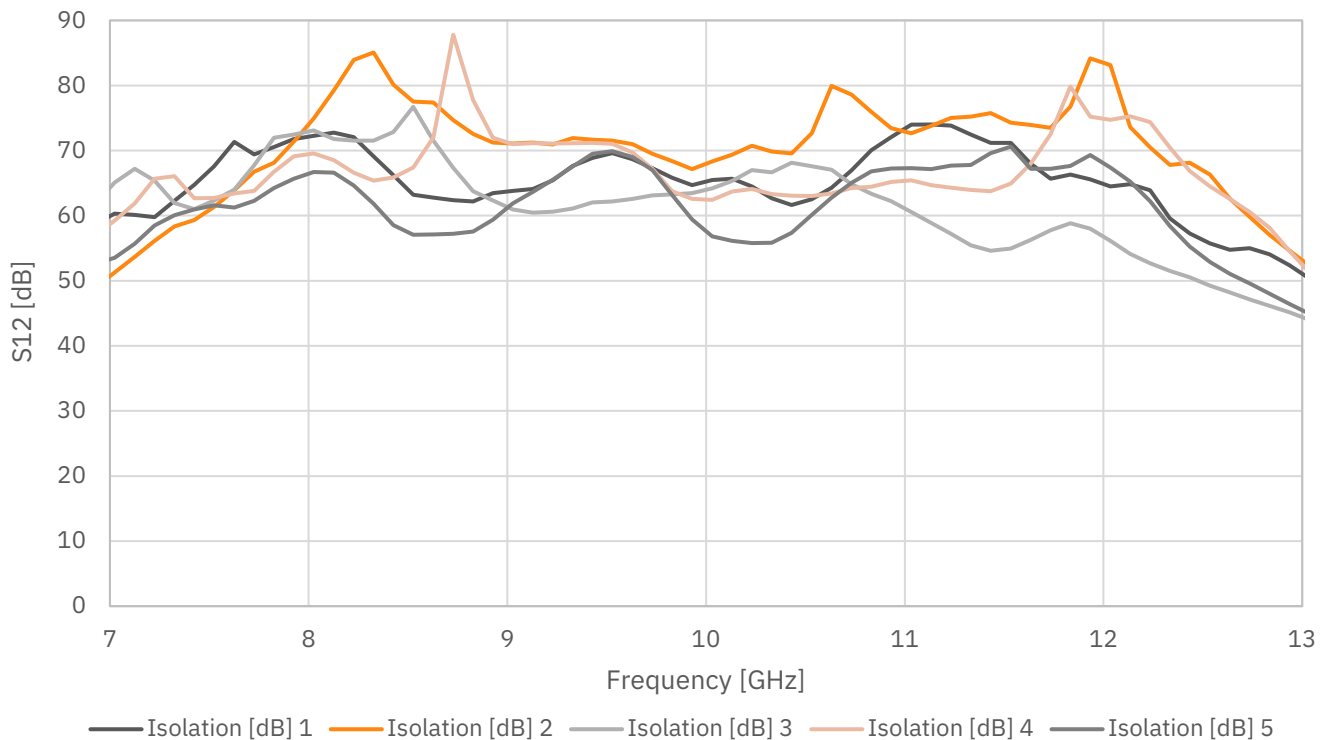

Port Match of 5 Units at 5 K

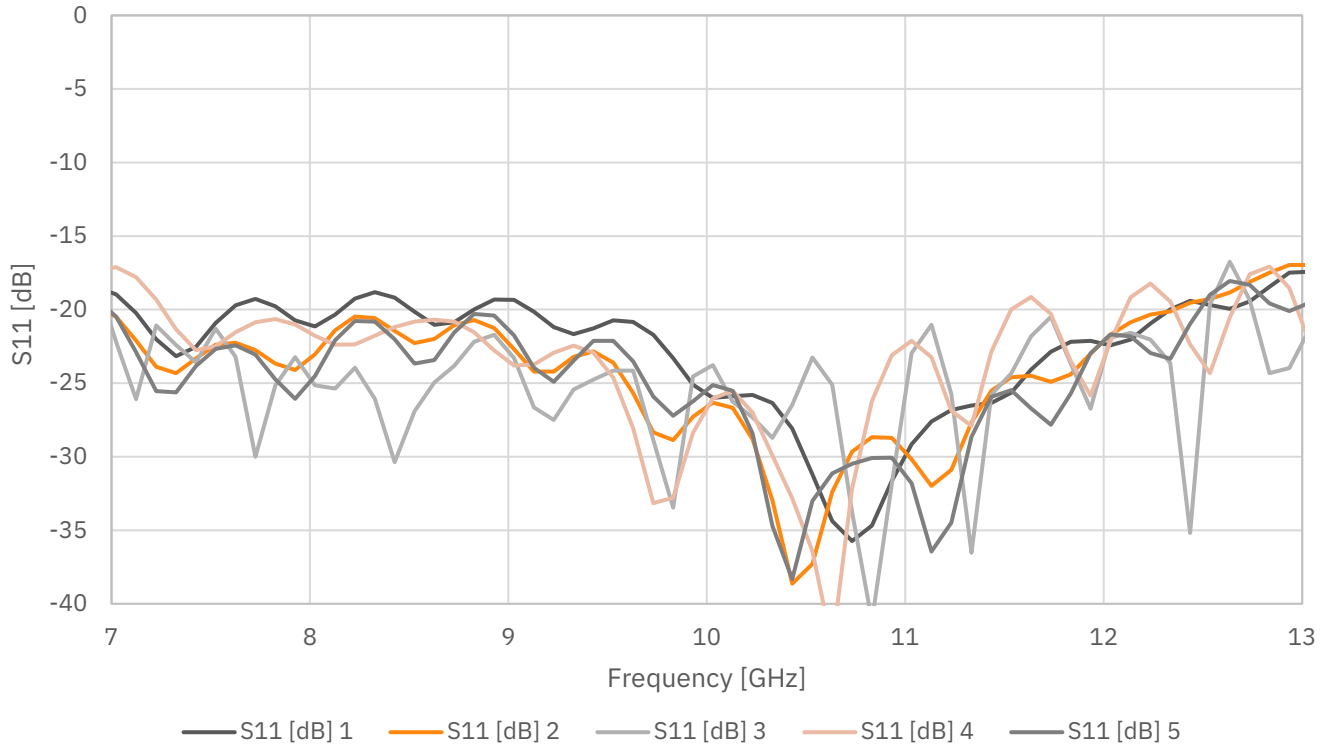

Dimensions without additional shielding

Units: mm

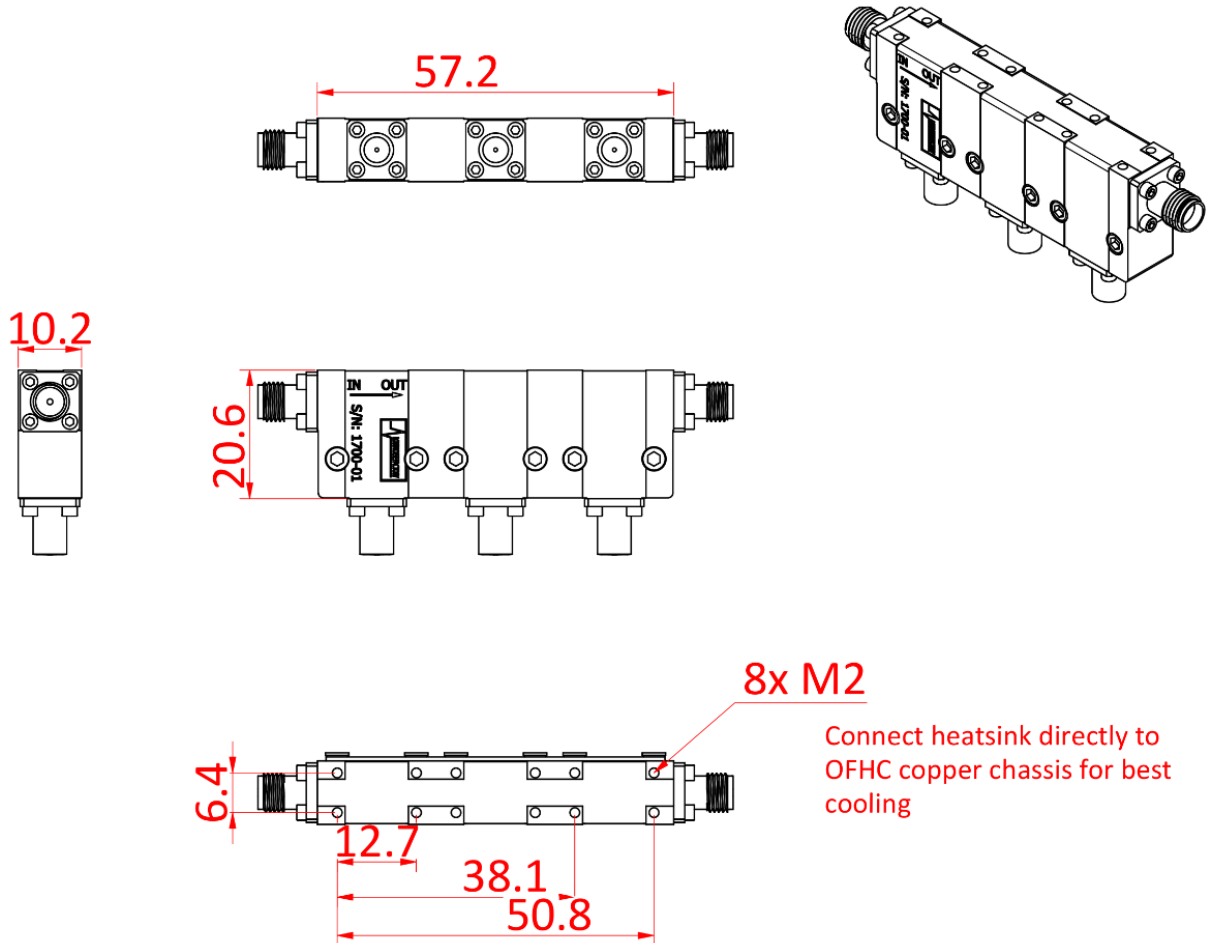

Dimensions with additional shielding

Units: mm

