

Datasheet

LNF-LNC2_4A

2-4 GHz Cryogenic Low Noise Amplifier

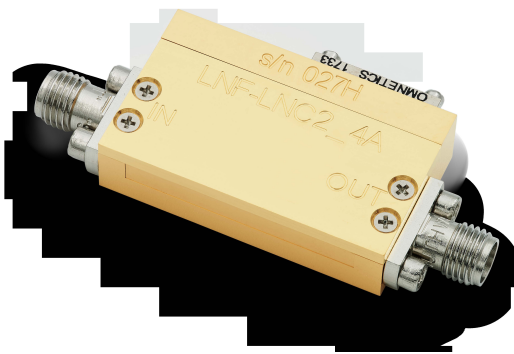

Product Features

RF Bandwidth	2-4 GHz
Noise Temperature	1.3 K
Noise Figure	0.02 dB
Gain	34 dB
DC power (typical)	$V_{ds} = 0.8 \text{ V}$, $I_{ds} = 16 \text{ mA}^*$
RF Connectors	Female SMA**
DC Connectors	9-pin Female Nano-D
One gate and one drain supply only	

* See test report for actual optimum bias for your unit

** Contact factory for alternative configuration

Absolute maximum ratings		
Parameter	Min	Max
V_{ds}	-0.5 V	2.7 V
I_{ds}		100 mA
V_{gs}	-20 V	20 V
DC Voltage on Input and Output	-30 V	30 V
RF Input Power		0 dBm
Operating Temperature	< 3 K	40 °C

Typical Characteristics		
Parameter	Value	Unit
V_{gs}	+3.2	V
IRL	5	dB
ORL	15	dB
Output P1dB	-8	dBm
OIP3	-2	dBm
Weight	17	grams

LNF-LNC2_4A is an ultra-low noise cryogenic amplifier using LNF's proprietary InP HEMT technology. MMIC technology ensures excellent unit-to-unit variation. The LNA is packaged in a coaxial module using industry standard SMA connectors for the RF ports and Nano-D to provide the DC. The lightweight gold plated aluminum module measures 33.0x19.75x7.80 mm excluding the connectors. The LNA is not hermetic and must be operated in a vacuum environment when below the dewpoint. All amplifiers are tested at 296 and 5 K and delivered with a test report.

Measured data, $T_{amb} = 296\text{ K}$

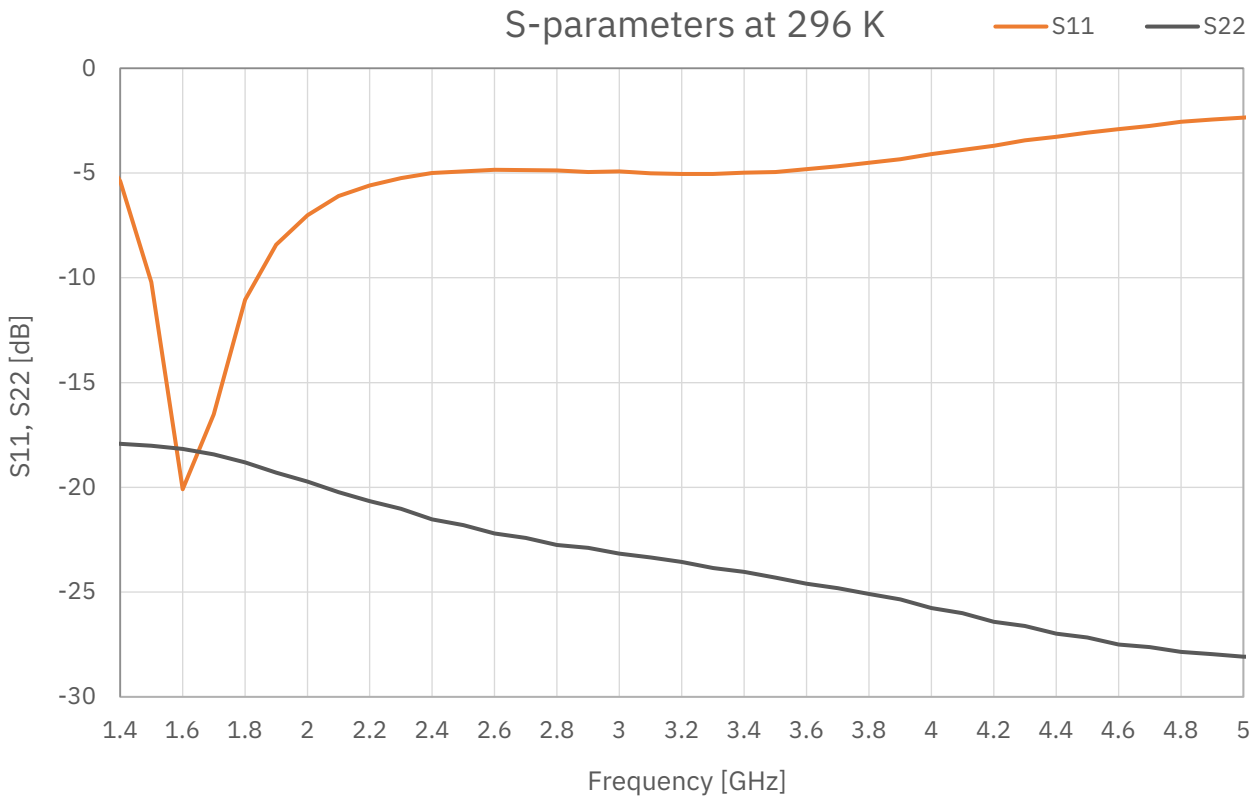
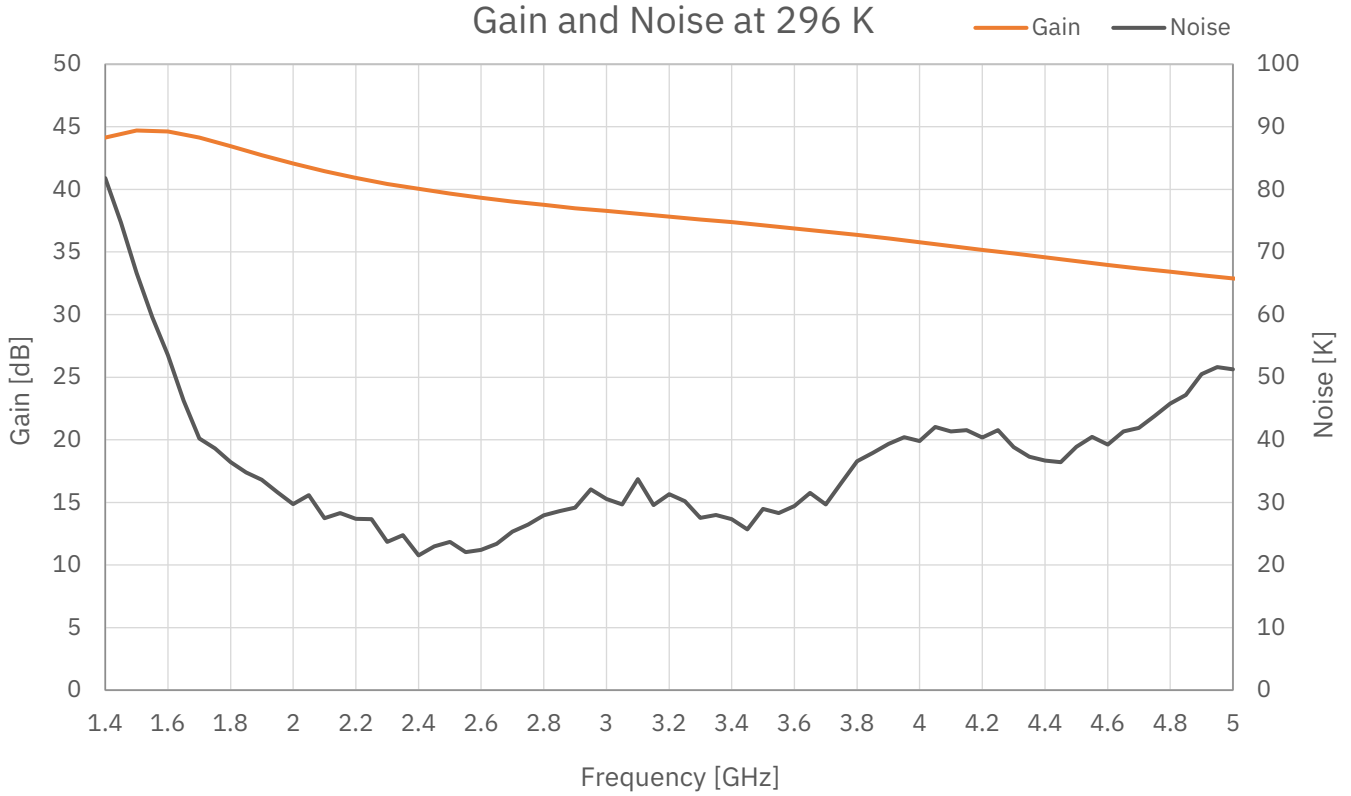

Measured data, $T_{amb} = 5\text{ K}$

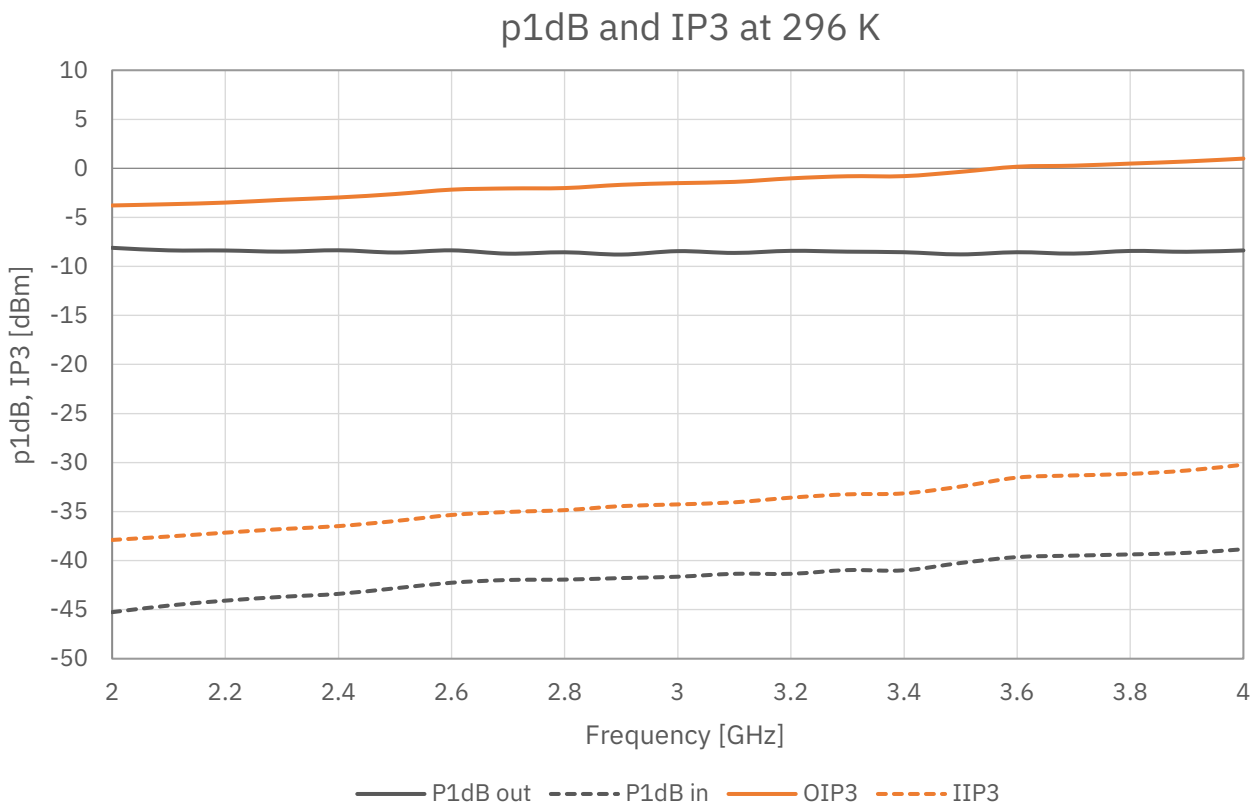
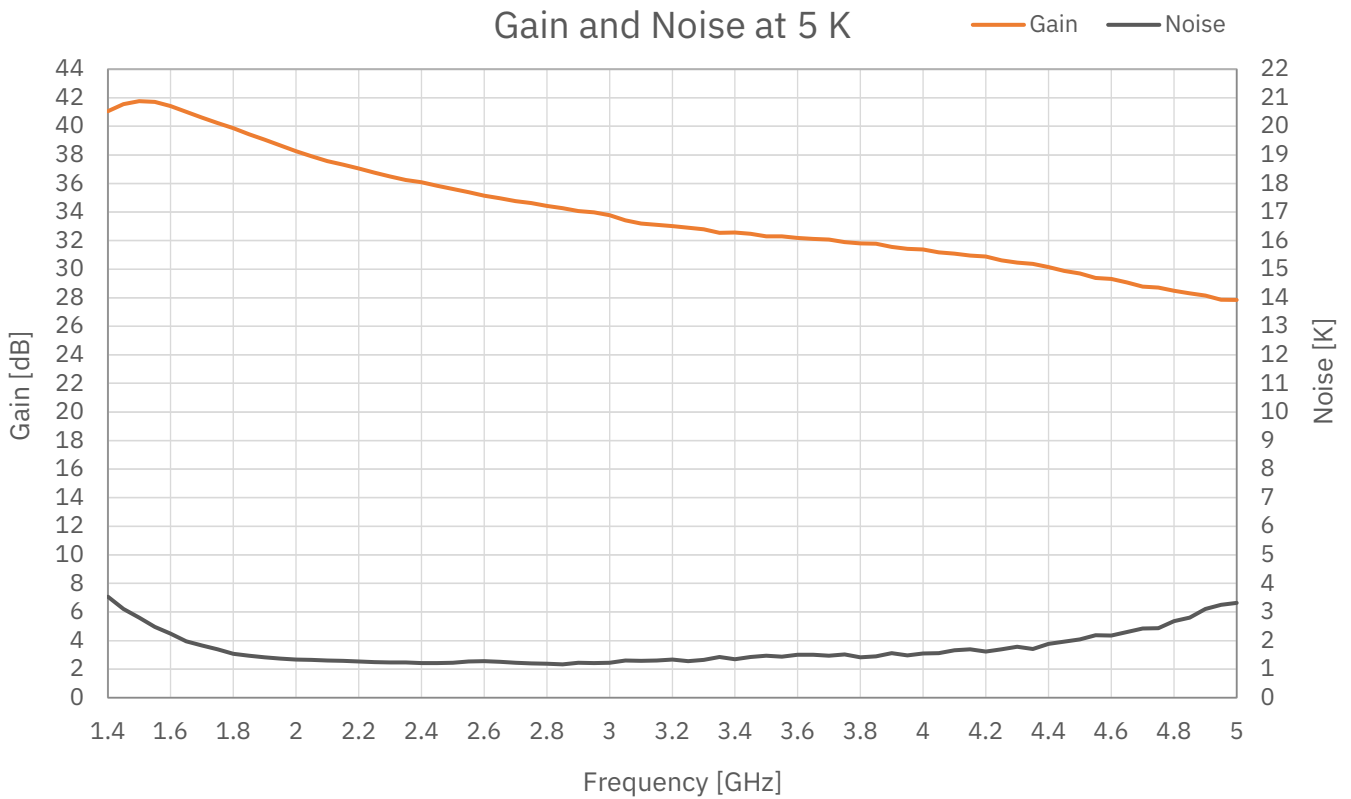

Dimensions and wiring

Units: mm

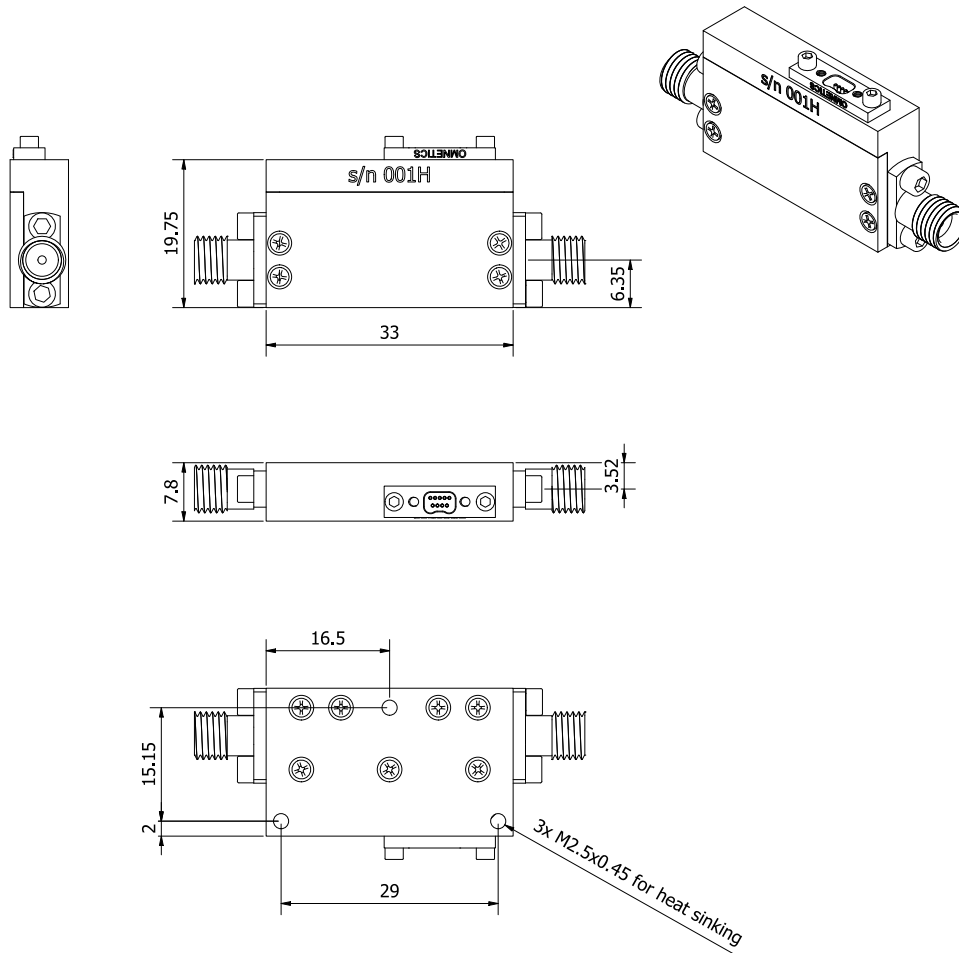

Nano-D panel connector seen from outside the LNA

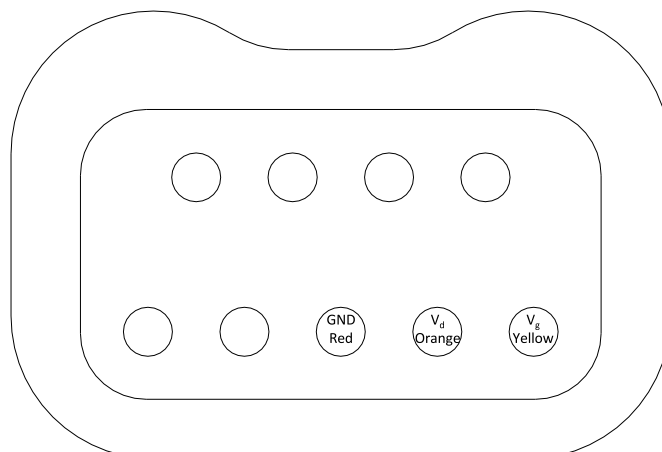

Biasing procedure

For safe operation of the LNA, please carefully follow the instructions below. Always honor the maximum ratings stated in the datasheet.

A. With constant current supply, e.g. LNF-PS_3, LNF-PS3b and LNF-PS_EU2

Power up:

1. Switch on the power supply
2. Double check that V_d is set to the nominal voltage in the datasheet
3. Connect the LNA's RF input and output to your grounded test set-up
4. Connect the power supply to the LNA
5. Check that the measured I_{ds} is equal to the nominal value in this datasheet. Tune to the correct value if necessary.
6. Before starting a cool down, make sure that the power supply is set to the stated values at 5K. Do not cool down with the power supply set to the room temperature values.

Power down:

1. Disconnect the power supply from the LNA
2. Switch off the power supply

B. With constant voltage supply, e.g. LNF-PS_1

Power up:

1. Switch on the power supply
2. Set V_d and V_g to the nominal voltages stated in this datasheet
3. Connect the LNA's RF input and output to your grounded test set-up
4. Connect the power supply to the LNA
5. Fine tune V_g to get the nominal I_{ds} stated in this datasheet. The actual V_g can deviate a bit from the value in the datasheet depending on ground wire resistance in your set-up.
6. Before starting a cool down, make sure that the power supply is set to the stated values at 5K. Do not cool down with the power supply set to the room temperature values.

Power down:

1. Disconnect the power supply from the LNA
2. Switch off the power supply